

Calculer  $x$  pour chaque figure de 1 à 10.

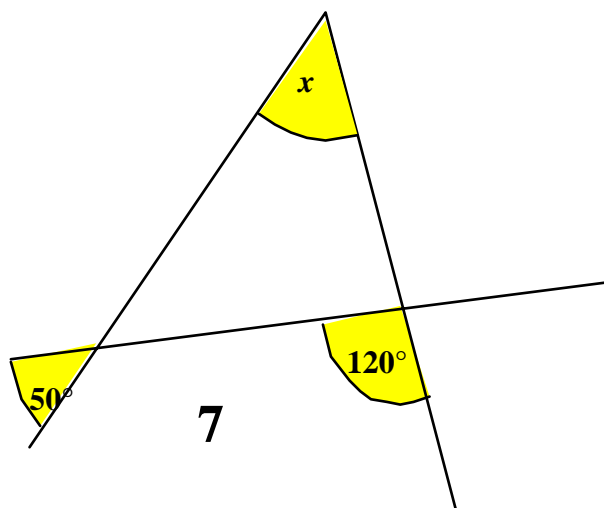

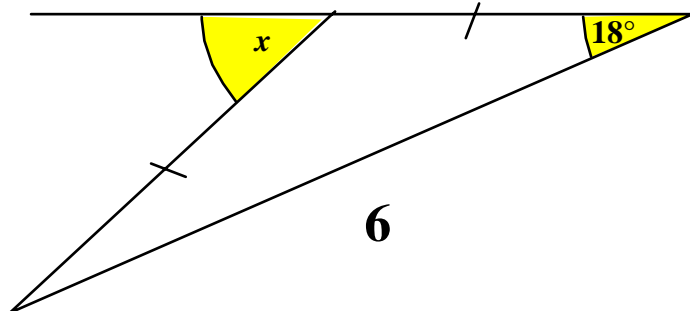

Calculer le plus d'angles dans chaque figure de 11 à 13.

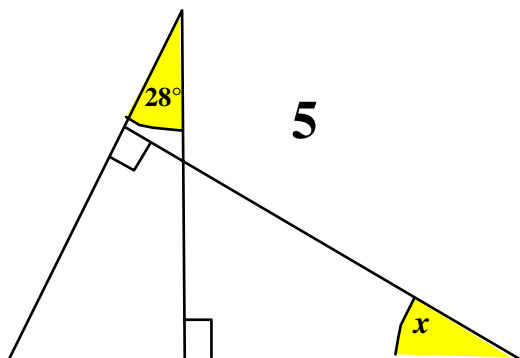
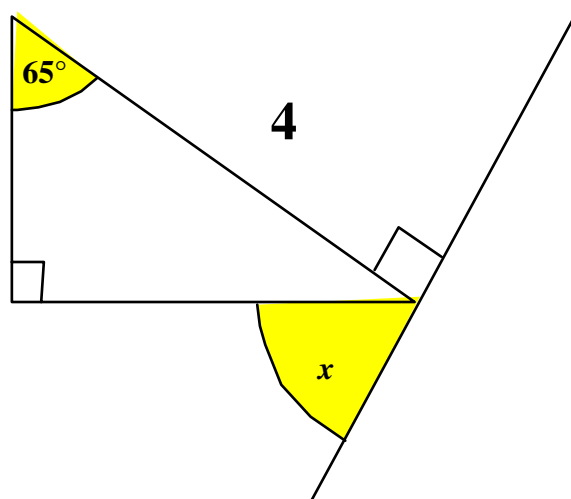
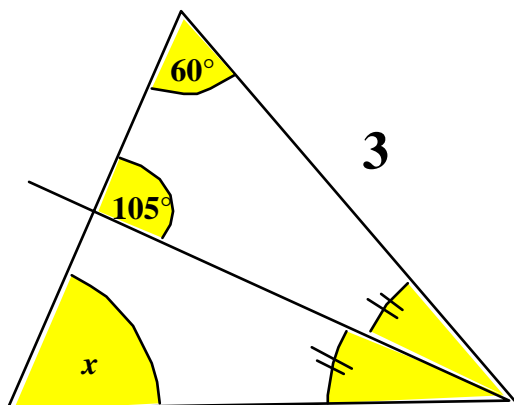
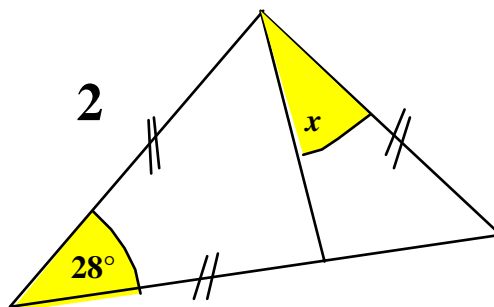
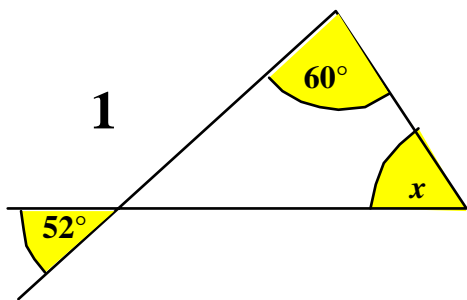
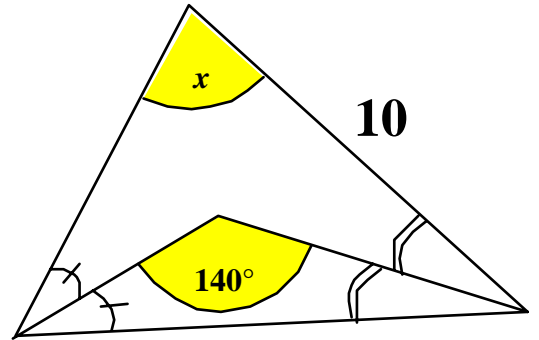
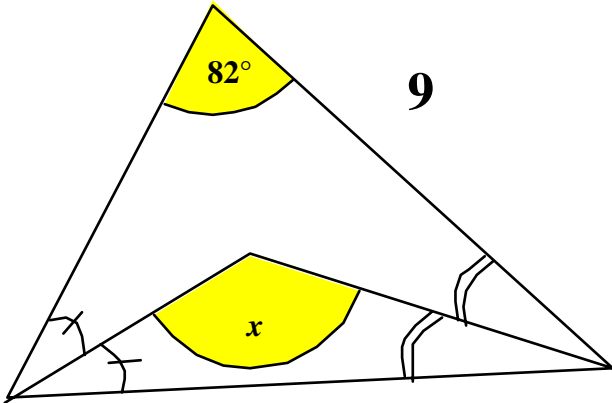
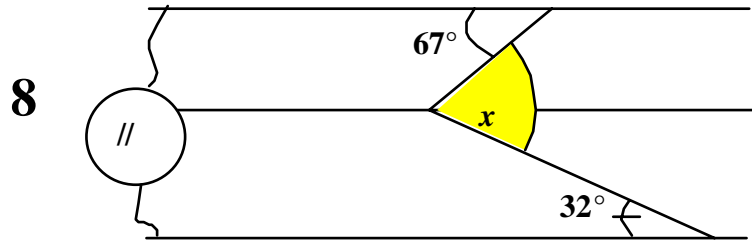